

Thyristor Surge Suppressors (TSS)

P0080SD - P3500SD Series - DO-214AA(SMB)

@10/700 μ S, 4KV

Description

P0080SD - P3500SD Series are designed to protect broadband equipment such as modems, line card, CPE and DSL from damaging over-voltage transients.

The series provides a surface mount solution that enables equipment to comply with global regulatory standards.

Features and Benefits

- ◆ Low voltage overshoot
- ◆ Low on-state voltage
- ◆ Does not degrade surge capability after multiple surge events within limit
- ◆ Fails short circuit when surged in excess of ratings
- ◆ Low Capacitance

Applicable Global Standards

- ◆ TIA-968-A
- ◆ ITU K.20/21 Enhanced level
- ◆ ITU K.20/21 Basic Level
- ◆ GR 1089 Inter building
- ◆ GR 1089 Inter building
- ◆ IEC 6100-4-5
- ◆ YD/T 1082
- ◆ YD/T 993
- ◆ YD/T 950

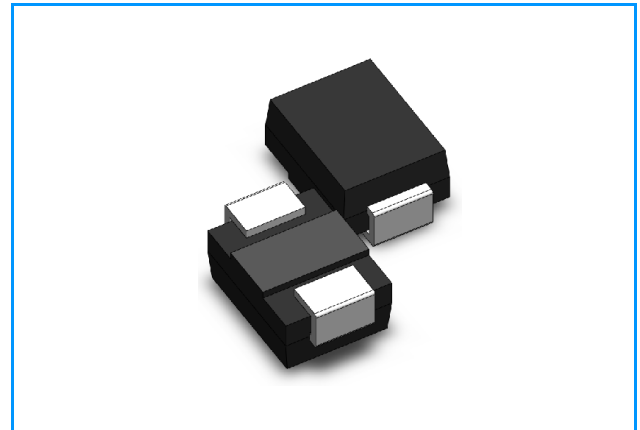

Schematic Symbol

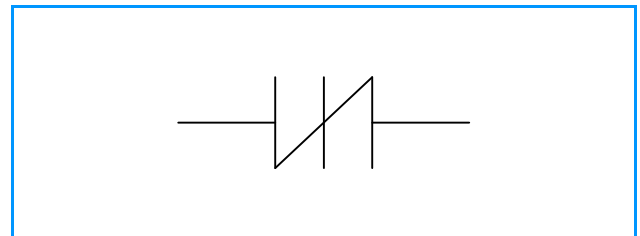

Electrical Parameters

| Parameter | Definition |
|-----------|---|
| I_S | Switching Current - maximum current required to switch to on state |
| I_{DRM} | Leakage Current - maximum peak off-state current measured at V_{DRM} |
| I_H | Holding Current - minimum current required to maintain on state |
| I_T | On-state Current - maximum rated continuous on-state current |
| V_S | Switching Voltage - maximum voltage prior to switching to on state |
| V_{DRM} | Peak Off-state Voltage - maximum voltage that can be applied while maintaining off state |
| V_T | On-state Voltage - maximum voltage measured at rated on-state current |
| C_0 | Off-state Capacitance - typical capacitance measured in off state |

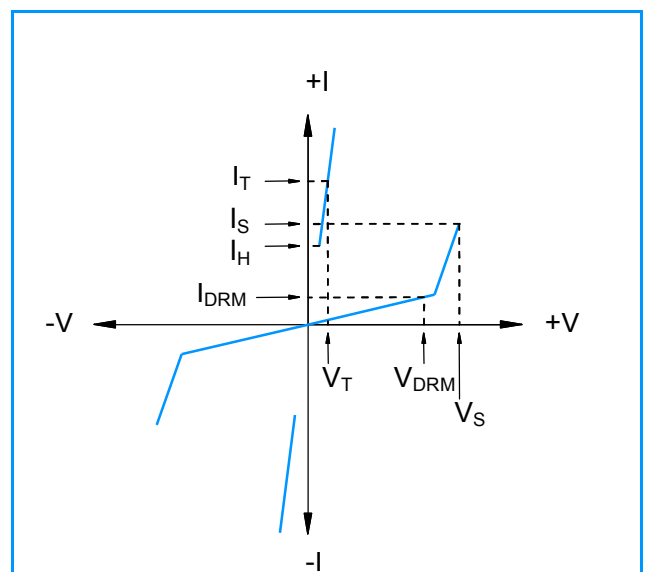

Thyristor Surge Suppressors (TSS)

P0080SD - P3500SD Series - DO-214AA(SMB) @10/700 μ S, 4KV

Electrical Characteristics

| Part Number | Marking | V_{DRM} @ $I_{DRM}=5\mu A$ | V_S @100V/ μS | V_T @ $I_T=2.2A$ | I_S | I_T | I_H | C_0 @1MHz | |
|-------------|---------|---------------------------------|-------------------------|-----------------------|--------|-------|--------|----------------|--------|
| | | V min | V max | V max | mA max | A max | mA min | pF min | pF max |
| P1800SD | P18D | 170 | 220 | 3 | 800 | 2.2 | 150 | 15 | 35 |
| P2300SD | P23D | 190 | 260 | 3 | 800 | 2.2 | 150 | 15 | 30 |
| P2600SD | P26D | 220 | 300 | 3 | 800 | 2.2 | 150 | 15 | 30 |
| P3100SD | P31D | 275 | 350 | 3 | 800 | 2.2 | 150 | 15 | 30 |
| P3500SD | P35D | 320 | 400 | 3 | 800 | 2.2 | 150 | 15 | 30 |

Notes:

- Absolute maximum ratings measured at $T_A=25^{\circ}C$ (unless otherwise noted).
- Devices are bi-directional.

Surge Ratings

| Series | 1.2/50 μS^1 | 10/1000 μS^1 | 5/310 μS^1 | I_{TSM} 50/60 Hz | di/dt |
|--------|------------------|-------------------|------------------|-----------------------|-------|
| | 8/20 μS^2 | 10/1000 μS^2 | 10/700 μS^2 | | |
| | A min | A min | A min | | |
| D | 200 | 75 | 100 | 25 | 500 |

Notes:

- Current waveform in μs
 - Voltage waveform in μs
- Peak pulse current rating (I_{PP}) is repetitive and guaranteed for the life of the product.
 - I_{PP} ratings applicable over temperature range of $-40^{\circ}C$ to $+85^{\circ}C$
 - The device must initially be in thermal equilibrium with $-40^{\circ}C < T_J < +150^{\circ}C$

Thermal Considerations

| Package | Symbol | Parameter | Value | Unit |
|---|-----------------|---|---------------|---------------|
| DO-214AA  | T_J | Operating Junction Temperature Range | - 40 to + 150 | $^{\circ}C$ |
| | T_S | Storage Temperature Range | - 40 to +150 | $^{\circ}C$ |
| | $R_{\theta JA}$ | Thermal Resistance: Junction to Ambient | 90 | $^{\circ}C/W$ |

Thyristor Surge Suppressors (TSS)

P0080SD - P3500SD Series - DO-214AA(SMB) @10/700μS, 4KV

Characteristic Curves

Figure 1 - V-I Characteristics

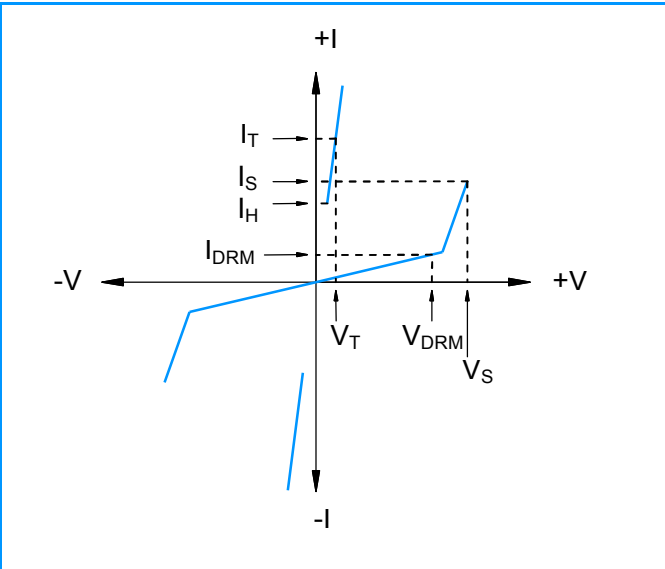

Figure 2 - $t_r \times t_d$ Pulse Waveform

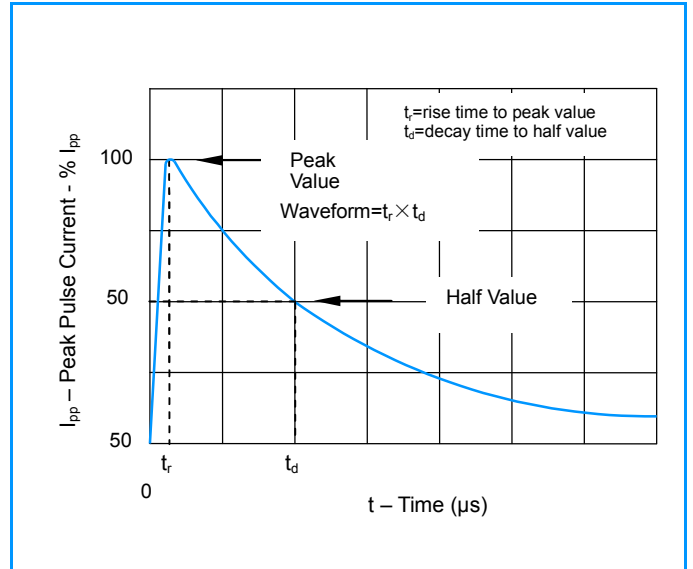

Figure 3 - Normalized V_s Change Versus Junction Temperature

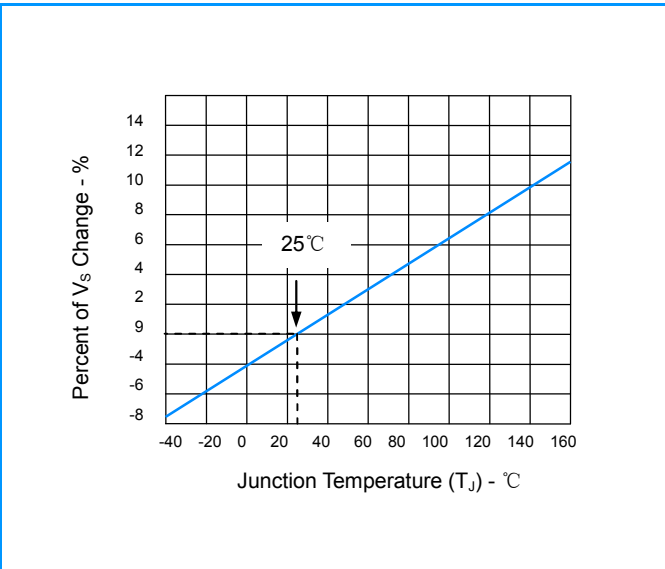
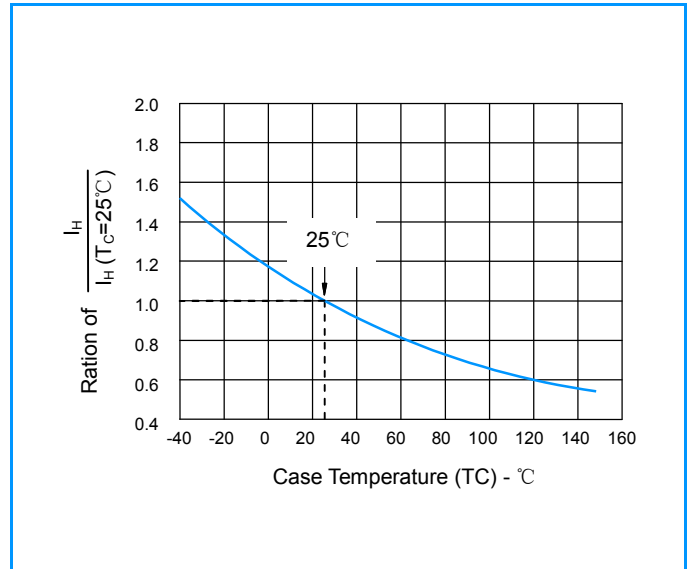

Figure 4 - Normalized DC Holding Current Versus Case Temperature



Thyristor Surge Suppressors (TSS)

P0080SD - P3500SD Series - DO-214AA(SMB)

@10/700 μ S, 4KV

Environmental Specifications

| | |
|---|--|
| High Temp Voltage Blocking | 80% Rated VDRM (VAC Peak) +125°C or +150°C, Lead Material Copper Alloy High Temp Voltage Blocking 504 or 1008 hrs. MIL-STD-750 (Method 1040) JEDEC, JESD22-A-101 |
| Temp Cycling | -65°C to +150°C, 15 min. dwell, 10 up to 100 cycles. MIL-STD-750 (Method 1051) EIA/JEDEC, JESD22-A104 |
| Biased Temp & Humidity | 52 VDC (+85°C) 85%RH, 504 up to 1008 hrs. EIA/JEDEC, JESD22-A-101 |
| High Temp Storage | +150°C 1008 hrs. MIL-STD-750 (Method 1031) JEDEC, JESD22-A-101 |
| Low Temp Storage | -65°C, 1008 hrs. |
| Thermal Shock | 0°C to +100°C, 5 min. dwell, 10 sec. transfer, Thermal Shock 10 cycles. MIL-STD-750 (Method 1056) JEDEC, JESD22-A-106 |
| Autoclave (Pressure Cooker Test) | +121°C, 100%RH, 2atm, 24 up to 168 hrs. EIA/Cooker Test) JEDEC, JESD22-A-102 |
| Resistance to Solder Heat | +260°C, 30 secs. MIL-STD-750 (Method 2031 |
| Moisture Sensitivity Level | 85%RH, +85°C, 168 hrs., 3 reflow cycles Level (+260°C Peak). JEDEC-J-STD-020, Level 1 |

Physical Specifications

| | |
|------------------------|---|
| Lead Material | Copper Alloy |
| Terminal Finish | 100% Matte-Tin Plated |
| Body Material | UL recognized epoxy meeting flammability classification 94V-0 |

Soldering Parameters

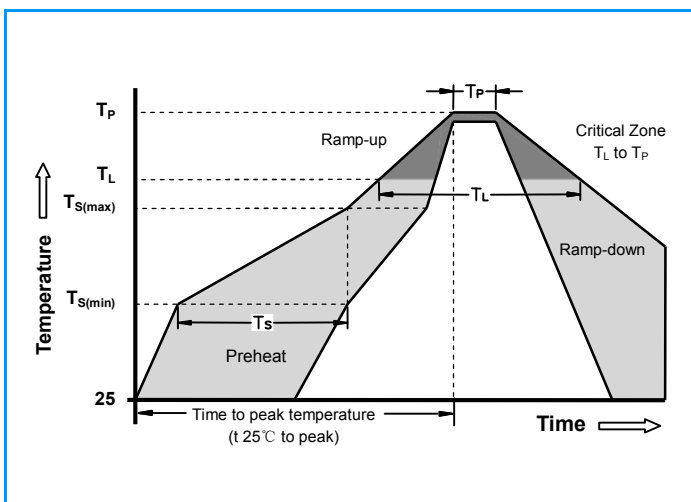

| | | |
|--|------------------------------------|--------------------|
| Reflow Condition | | Lead-free assembly |
| Pre Heat | -Temperature Min ($T_{s(min)}$) | +150°C |
| | -Temperature Max ($T_{s(max)}$) | +200°C |
| | -Time (min to max) (T_s) | 60 -180 Seconds |
| Average ramp up rate (Liquidus Temp T_L) to peak | | 3°C/Second Max |
| $T_{s(max)}$ to T_L - Ramp-up Rate | | 3°C/Second Max |
| Reflow | - Temperature (T_L) (Liquidus) | +217°C |
| | - Time (min to max) (T_L) | 60 -150 Seconds |
| Peak Temperature (T_P) | | 260 +0/-5°C |
| Time within 5°C of actual peak Temperature (t_p) | | 30 Seconds Max |
| Ramp-down Rate | | 6°C/Second Max |
| Time 25°C to peak Temperature (T_P) | | 8 minutes Max |
| Do not exceed | | +260°C |

Thyristor Surge Suppressors (TSS)

P0080SD - P3500SD Series - DO-214AA(SMB) @10/700μS, 4KV

Part Numbering

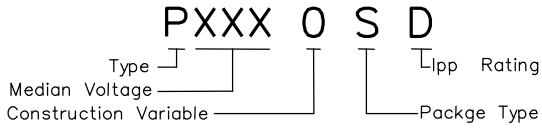

Part Marking

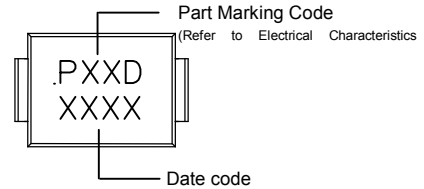

Dimensions DO-214AA

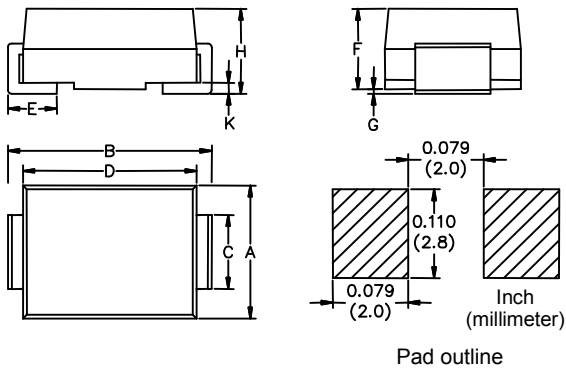

| Dimensions | Inches | | Millimeters | |
|------------|--------|-------|-------------|------|
| | Min | Max | Min | Max |
| A | 0.130 | 0.156 | 3.30 | 3.95 |
| B | 0.201 | 0.220 | 5.10 | 5.60 |
| C | 0.077 | 0.087 | 1.95 | 2.20 |
| D | 0.159 | 0.181 | 4.05 | 4.60 |
| E | 0.030 | 0.063 | 0.75 | 1.60 |
| F | 0.076 | 0.096 | 1.90 | 2.45 |
| G | 0.002 | 0.008 | 0.05 | 0.20 |
| H | 0.077 | 0.104 | 1.95 | 2.65 |
| K | 0.006 | 0.016 | 0.15 | 0.41 |

Packaging

| Part Number | Component Package | Quantity | Packaging Option | Packaging Specification |
|-------------|-------------------|----------|---------------------------|-------------------------|
| Pxxx0SD | DO-214AA | 2500 | Tape & Reel -12mm/13"tape | EIA -481 - D |

Tape and Reel Specifications

